

# AVX

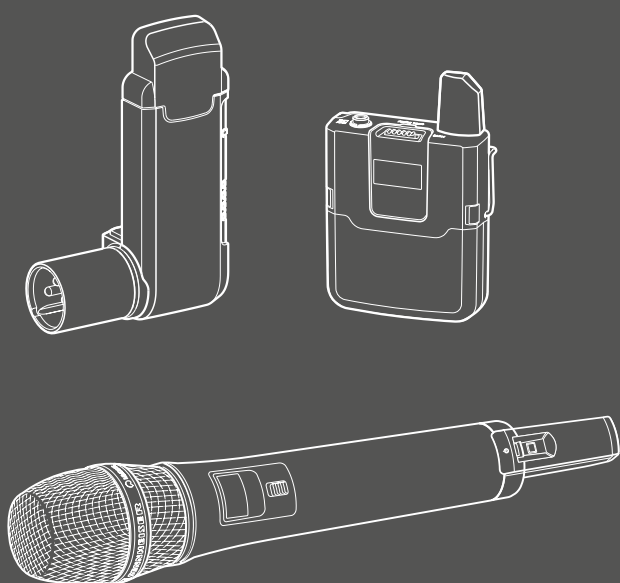

Technische Daten

### EKP AVX

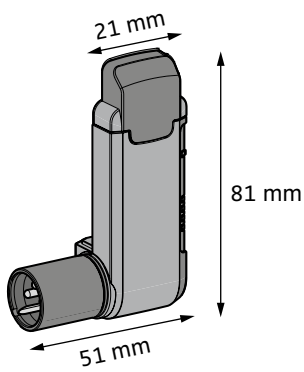

### SKM AVX/SKM AVX-S

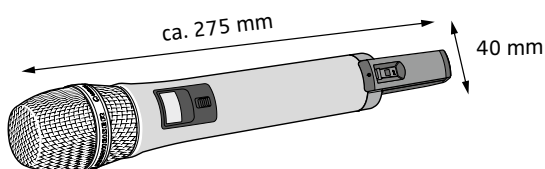

### SK AVX

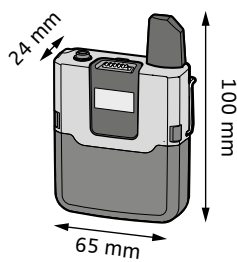

## System

NF-Übertragungsbereich	20 bis 20.000 Hz
Dynamikbereich	> 120 dB (A)
THD (1 kHz)	typ. 0,1 %
Audio Sampling	24 bit/48 kHz
Signal/Rauschabstand	> 90 dB (A)
HF-Frequenzbereiche	1880 bis 1930 MHz (länderspezifisch)
Modulation	GFSK mit Datenrückkanal
Übertragungssystem	TDMA fast switching antenna diversity
Latenz	19 ms
relative Luftfeuchte	max. 95 %
Temperaturbereich*	im Betrieb: -10 °C bis +55 °C Lagerung: -20 °C bis +70 °C

\* Die Batterie-Eigenschaften beeinflussen diesen Temperaturbereich

## EKP AVX



HF-Empfindlichkeit	< -90 dBm
Sendeleistung Rückkanal	typ. 15 dBm e.i.r.p.
Audio Output	einstellbar
XLR, symmetrisch	-30 dBu bis 0 dBu in 4 Stufen
Spannungsversorgung	BA 20 (Li-Ion 3,7 V DC)
Akkulaufzeit	> 4 h
NF-Anschlussbuchse	XLR, male
Gewicht (incl. BA 20)	ca. 87 g

## SKM AVX

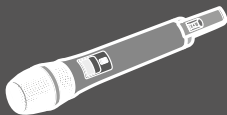

Sendeleistung	adaptiv bis zu 250 mW (länderspezifisch)
NF-Übertragungsbereich	50 bis 20.000 Hz
Eingangsempfindlichkeit	Automatic Sensitivity Adjustment
Spannungsversorgung	Akkupack: BA 10 (Li-Ion, 3,6 V) Batterien*: 2 x Mignon AA (1,5 V)
Batterielaufzeit	Akkupack: typ. 15 h Batterien*: typ. 10 h
Display	LCD
Gewicht (ohne Akkupack)	ca. 282 g inkl. Kapsel

\* optionales Zubehör

## SK AVX



Sendeleistung	adaptiv bis zu 250 mW (länderspezifisch)
NF-Übertragungsbereich	Mic: 50 bis 20.000 Hz Line: 20 bis 20.000 Hz
Max. Eingangspegel	Mic: 2,2 V RMS Line: 3,3 V RMS
Eingangsimpedanz Line	1 M $\Omega$
Eingangsempfindlichkeit	Automatic Sensitivity Adjustment
Spannungsversorgung	Akkupack: BA 30 (Li-Ion, 3,7 V) Batterien*: 2x Mignon AA (1,5 V)
Batterielaufzeit	Akkupack: typ. 15 h Batterien*: typ. 11 h
NF-Anschlussbuchse	3,5 mm-Klinkenbuchse, verschraubbar Steckerbelegung: 
Gewicht (ohne Akkupack)	ca. 87 g

\* optionales Zubehör



## MMD 835-1 MMD 42-1

Mikrofontyp	dynamisch	
Empfindlichkeit	2,1 mV/Pa	1,8 mV/Pa
Richtcharakteristik	Niere	Kugel
Max. Schalldruckpegel	154 dB SPL	154 dB SPL

## ME 2-2



Mikrofontyp	dauerpolarisiertes Kondensatormikrofon
Empfindlichkeit	20 mV/Pa
Richtcharakteristik	Kugel
Max. Schalldruckpegel	130 dB SPL

## MKE 2





Mikrofontyp	dauerpolarisiertes Kondensatormikrofon
Empfindlichkeit	5 mV/Pa
Richtcharakteristik	Kugel
Max. Schalldruckpegel	142 dB SPL

### Anforderungen werden erfüllt für:

Europa		Funk EMV Sicherheit	EN 301406 EN 301489-1/-6 EN 60950-1 EN 62311 (SAR) EN 50581
USA		FCC 47 CFR 15	
Kanada		Industry Canada RSS 210 CAN ICES-3 (B)/NMB-3(B)	

### Zugelassen für:

USA	SKM SK EKP	FCC ID: DMOSKM1G9WE FCC ID: DMOSK1G9WE FCC ID: DMOEKP1G9WE			
Kanada	SKM SK EKP	IC: 2099A-SKM1G9WE IC: 2099A-SK1G9WE IC: 2099A-EKP1G9WE			
Australien/Neuseeland					
Japan		 SKM <table border="1" data-bbox="601 997 632 1026"><tr><td>R</td></tr></table> 202-SMC049 SK <table border="1" data-bbox="601 1026 632 1055"><tr><td>R</td></tr></table> 202-SMC050 EKP <table border="1" data-bbox="601 1055 632 1084"><tr><td>R</td></tr></table> 202-SMC051	R	R	R
R					
R					
R					



## NT 5-10U

Nenneingangsspannung	100 bis 240 V~
Netzfrequenz	50 oder 60 Hz
Nennausgangsspannung	5 V 
Ausgangsstrom	1 A
Stand-by-Leistungsaufnahme	≤ 0,1 W
Energie-Effizienz-Klasse	V
Betriebstemperatur	0 °C bis +40 °C
Lagertemperatur	-20 °C bis +70 °C
Relative Luftfeuchte	max. 90 %
Gewicht	ca. 55 g

### Anforderungen werden erfüllt für:

Europa		EMV Sicherheit RoHs	EN 55022, EN 55024 EN 60950-1 EN 50581
		Energie Effizienz Verordnung Nr. 1275/2008	
USA/ Kanada		EMV Sicherheit	FCC 47 CFR 15 B ICES 003, CAN ICES-3(B)/NMB-3(B) UL 60950-1 CAN/CSA-C22.2 No. 60950-1
Australien		EMV Sicherheit	AS/NZ CISPR 22 AS/NZL 60950.1

### Zertifiziert nach:

Europa	ENEC 22 SIQ
USA/Kanada	
Australien/Neuseeland	
Japan	 ゼンハイザージャパン(株)

## Akkupacks



	BA 10	BA 20	BA 30
Ladekapazität	2200 mAh	430 mAh	2030 mAh
Ausgangsspannung	3,6 V	3,7 V	3,7 V

### Anforderungen werden erfüllt für:

Europa		EMV Sicherheit	EN 301489-1/-6/-17 IEC/EN 62133
USA/Kanada		Akkuzellen Akkupack	UL 1642 UL 2054
Japan		DENAN Ordinance Article 1; Appendix 9 Lithium Ion	
Korea		Sicherheit	K 62133
UN Transporttest		gemäß UN-Prüfhandbuch Teil III, Abschnitt 38.3 Lithiumbatterien	

### Zertifiziert nach:

USA/Kanada



Japan



センハイザージャパン(株)

Korea



## Herstellereklärungen

### Garantie

- Sennheiser electronic GmbH & Co. KG übernimmt für dieses Produkt eine Garantie von 24 Monaten.
- Die aktuell geltenden Garantiebedingungen können Sie über das Internet [www.sennheiser.com](http://www.sennheiser.com) oder Ihren Sennheiser-Partner beziehen.

### In Übereinstimmung mit folgenden Anforderungen

- WEEE-Richtlinie (2012/19/EU)  
 Bitte entsorgen Sie die Produkte am Ende ihrer Nutzungsdauer bei Ihrer örtlichen kommunalen Sammelstelle oder im Recycling Center.
- Batterierichtlinie (2006/66/EG)  
Die mitgelieferten Akkus oder Batterien sind recyclingpflichtig. Bitte entsorgen Sie Akkus bzw. Batterien über offizielle Sammelstellen oder den Fachhandel. Entsorgen Sie nur leere Batterien oder Akkus, um den Umweltschutz zu gewährleisten.

### CE-Konformität

- **CE 0682**
- R&TTE-Richtlinie (1999/5/EG)
- RoHS-Richtlinie (2011/65/EU)
- EMV-Richtlinie (2004/108/EU)
- Niederspannungs-Richtlinie (2006/95/EU)

Die Erklärungen stehen im Internet unter [www.sennheiser.com](http://www.sennheiser.com) zur Verfügung. Vor Inbetriebnahme sind die jeweiligen länderspezifischen Vorschriften zu beachten.

# Licenses

## CELT Codec

Copyright (c) 2014 IETF Trust and the persons identified as authors of the code. All rights reserved.

Redistribution and use in source and binary forms, with or without modification, are permitted provided that the following conditions are met:

- Redistributions of source code must retain the above copyright notice, this list of conditions and the following disclaimer.
- Redistributions in binary form must reproduce the above copyright notice, this list of conditions and the following disclaimer in the documentation and/or other materials provided with the distribution.
- Neither the name of Internet Society, IETF or IETF Trust, nor the names of specific contributors, may be used to endorse or promote products derived from this software without specific prior written permission.

THIS SOFTWARE IS PROVIDED BY THE COPYRIGHT HOLDERS AND CONTRIBUTORS "AS IS" AND ANY EXPRESS OR IMPLIED WARRANTIES, INCLUDING, BUT NOT LIMITED TO, THE IMPLIED WARRANTIES OF MERCHANTABILITY AND FITNESS FOR A PARTICULAR PURPOSE

ARE DISCLAIMED. IN NO EVENT SHALL THE COPYRIGHT OWNER OR CONTRIBUTORS BE LIABLE FOR ANY DIRECT, INDIRECT, INCIDENTAL, SPECIAL, EXEMPLARY, OR CONSEQUENTIAL DAMAGES (INCLUDING, BUT NOT LIMITED TO, PROCUREMENT OF SUBSTITUTE GOODS OR SERVICES; LOSS OF USE, DATA, OR PROFITS; OR BUSINESS INTERRUPTION) HOWEVER CAUSED AND ON ANY THEORY OF LIABILITY, WHETHER IN CONTRACT, STRICT LIABILITY, OR TORT (INCLUDING NEGLIGENCE OR OTHERWISE) ARISING IN ANY WAY OUT OF THE USE OF THIS SOFTWARE, EVEN IF ADVISED OF THE POSSIBILITY OF SUCH DAMAGE.

## Ubuntu Font License

Version 1.0

### Preamble

This license allows the licensed fonts to be used, studied, modified and redistributed freely. The fonts, including any derivative works, can be bundled, embedded, and redistributed provided the terms of this license are met. The fonts and derivatives, however, cannot be released under any other license. The requirement for fonts to remain under this license does not require any document created using the fonts or their derivatives to be published under this license, as long as the primary purpose of the document is not to be a vehicle for the distribution of the fonts.

### Permission & Conditions

This license does not grant any rights under trademark law and all such rights are reserved.

Permission is hereby granted, free of charge, to any person obtaining a copy of the Font Software, to propagate the Font Software, subject to the below conditions:

1. Each copy of the Font Software must contain the above copyright notice and this license. These can be included either as stand-alone text files, human-readable headers or in the appropriate machine-readable metadata fields within text or binary files as long as those fields can be easily viewed by the user.
2. The font name complies with the following:
  1. The Original Version must retain its name, unmodified.
  2. Modified Versions which are Substantially Changed must be renamed to avoid use of the name of the Original Version or similar names entirely.
  3. Modified Versions which are not Substantially Changed must be renamed to both
    1. retain the name of the Original Version and
    2. add additional naming elements to distinguish the Modified

Version from the Original Version. The name of such Modified Versions must be the name of the Original Version, with „derivative X“ where X represents the name of the new work, appended to that name.

3. The name(s) of the Copyright Holder(s) and any contributor to the Font Software shall not be used to promote, endorse or advertise any Modified Version, except
  1. as required by this license,
  2. to acknowledge the contribution(s) of the Copyright Holder(s) or
  3. with their explicit written permission.
4. The Font Software, modified or unmodified, in part or in whole, must be distributed entirely under this license, and must not be distributed under any other license. The requirement for fonts to remain under this license does not affect any document created using the Font Software, except any version of the Font Software extracted from a document created using the Font Software may only be distributed under this license.

## Termination

This license becomes null and void if any of the above conditions are not met.

## Disclaimer

THE FONT SOFTWARE IS PROVIDED „AS IS“, WITHOUT WARRANTY OF ANY KIND, EXPRESS OR IMPLIED, INCLUDING BUT NOT LIMITED TO ANY WARRANTIES OF MERCHANTABILITY, FITNESS FOR A PARTICULAR PURPOSE AND NONINFRINGEMENT OF COPYRIGHT, PATENT, TRADEMARK, OR OTHER RIGHT. IN NO EVENT SHALL THE COPYRIGHT HOLDER BE LIABLE FOR ANY CLAIM, DAMAGES OR OTHER LIABILITY, INCLUDING ANY GENERAL, SPECIAL, INDIRECT, INCIDENTAL, OR CONSEQUENTIAL DAMAGES, WHETHER IN AN ACTION OF CONTRACT, TORT OR OTHERWISE, ARISING FROM, OUT OF THE USE OR INABILITY TO USE THE FONT SOFTWARE OR FROM OTHER DEALINGS IN THE FONT SOFTWARE.







Sennheiser electronic GmbH & Co. KG

Am Labor 1, 30900 Wedemark, Germany

[www.sennheiser.com](http://www.sennheiser.com)

Publ. 01/15, 554644/A03