

HA5-4K

HDMI to SDI Mini-Converter



Installation and Operation Guide

Version 1.7
Published March 30, 2017



Notices

Trademarks

AJA® and Because it matters.® are registered trademarks of AJA Video Systems, Inc. for use with most AJA products. AJA™ is a trademark of AJA Video Systems, Inc. for use with recorder, router, software and camera products. Because it matters.™ is a trademark of AJA Video Systems, Inc. for use with camera products.

CION®, Corvid Ultra®, Io®, Ki Pro®, KONA®, KUMO®, ROI® and T-Tap® are registered trademarks of AJA Video Systems, Inc.

AJA Control Room™, KiStor™, Science of the Beautiful™, TruScale™, TruZoom™, V2Analog™ and V2Digital™ are trademarks of AJA Video Systems, Inc.

AirPort, Apple, Apple logo, AppleShare, AppleTalk, FireWire, iPod, iPod touch, Mac, Macintosh and ProRes, are registered trademarks of Apple Inc. Final Cut Pro, QuickTime and QuickTime logo are trademarks of Apple Inc.

Avid, Avid DNxHD and Media Composer are registered trademarks of Avid Technology, Inc.

Adobe is a registered trademark of Adobe Systems Incorporated in the United States and/or other countries.

HDMI, the HDMI logo and High-Definition Multimedia Interface are trademarks or registered trademarks of HDMI Licensing, LLC.

DVI is a registered trademark of DDWG.

TASCAM is a registered trademark of TEAC Corporation.

Dolby and the double-D Dolby logo are registered trademarks of Dolby Laboratories Licensing Corporation.

openGear® Ross, ROSS, ROSS®, and MLE are registered trademarks of Ross Video.

DashBoard Control System™ is a trademark of Ross Video.

All other trademarks are the property of their respective holders.

Copyright

Copyright © 2017 AJA Video Systems, Inc. All rights reserved. All information in this manual is subject to change without notice. No part of the document may be reproduced or transmitted in any form, or by any means, electronic or mechanical, including photocopying or recording, without the express written permission of AJA Video Systems, Inc.

Contacting AJA Support

When calling for support, have all information at hand prior to calling. To contact AJA for sales or support, use any of the following methods:

Telephone	+1.530.271.3190
FAX	+1.530.271.3140
Web	http://www.aja.com
Support Email	support@aja.com
Sales Email	sales@aja.com

Table of Contents

Notices	2
Trademarks	2
Copyright	2
Contacting AJA Support	2
Chapter 1 – Introduction	4
Overview	4
Default Operation	4
AJA Mini-Config Control	4
Features	5
Block Diagram	5
I/O Connections	6
Installation	6
Chapter 2 – Operation	7
USB Control and Setup—Using AJA Mini-Config	7
Acquiring AJA Mini-Config	7
Mini-Converter Documentation	7
Installing AJA Mini-Config	7
PC Installation	7
Mac Installation	8
Running AJA Mini-Config	9
PC Startup	9
Mac Startup	9
Saving Setups	9
Operating AJA Mini-Config	10
Running Multiple Mini-Converters	10
Tabbed Screens	11
Input Tab Screen	12
Output Tab Screen	13
HDR Tab Screen	15
Audio Tab Screen	17
Update Tab Screen	18
Software Update Procedure	18
Info Tab Screen	19
Appendix A – Specifications	20
HA5-4K Tech Specs	20
Appendix B – Safety and Compliance	23
Five Year Warranty	31
Limited Warranty	31

Chapter 1 – Introduction



Overview

AJA's HA5-4K Mini-Converter provides high-quality conversion of HDMI v2.0 to 4K SDI with 4 x 3G-SDI outputs. HA5-4K allows conversion of HDMI video from various sources, including DSLR's, mirrorless cameras, action cameras, or prosumer 4K video cameras to 4K SDI for use in professional workflows. The HA5-4K outputs SDI video with the same format and frame rate as the incoming HDMI video. The HA5-4K also supports both Square Division and Two Sample Interleave output mapping.

Default Operation

The HA5-4K auto configures to the connected HDMI input (no dipswitch settings required). The auto-configure function identifies the connected input and outputs the equivalent SDI format.

An SD or HD output signal uses only BNC SDI Out 1, and the remaining BNC output connectors are inactive by default. However, the DA function accessible with Mini-Config allows replication of the output signal on those extra output BNCs.

AJA Mini-Config Control

AJA's Mini-Config application is available for firmware updates and advanced configuration. Configuration set via Mini-Config is stored in the HA5-4K unit through subsequent power cycles.

Features

- HDMI to 4K/HD/SD-SDI (see "[Appendix A – Specifications](#)" on page 20 for a complete list of supported inputs).
- HDMI 2.0 support including:
 - 4:2:2/4:4:4/4:2:0 YCbCr
 - 4:4:4 RGB
 - 8, 10, or 12 bit (HFR 4K/UltraHD 4:4:4 limited to 8 bit)
 - 2 or 8 channels of embedded audio
- SDI support including:
 - SMPTE 425 Level A and B
 - Quadrant or 2SI mapping
 - 4:2:2/4:4:4 YCbCr
 - 4:4:4 RGB
 - 10 bit
 - 8 channels of embedded audio
 - Pad/Crop between 4K and UHD
 - P to PsF conversion
 - DA Function
- Support for HDMI 2.0a
 - HDR Static Metadata Descriptors
- Setup via PC/Mac using USB port and supplied USB cable (AJA Mini-Config configuration software application available via download from AJA website)
- Uses universal input +5V power supply AJA model DWP-U-R1 (included)
- 5 year warranty

NOTE: 3D is not supported in this converter.

NOTE: 720p 4:4:4 formats are not supported in this release.

Block Diagram

Figure 1. HA5-4K Converter, Simplified Block Diagram

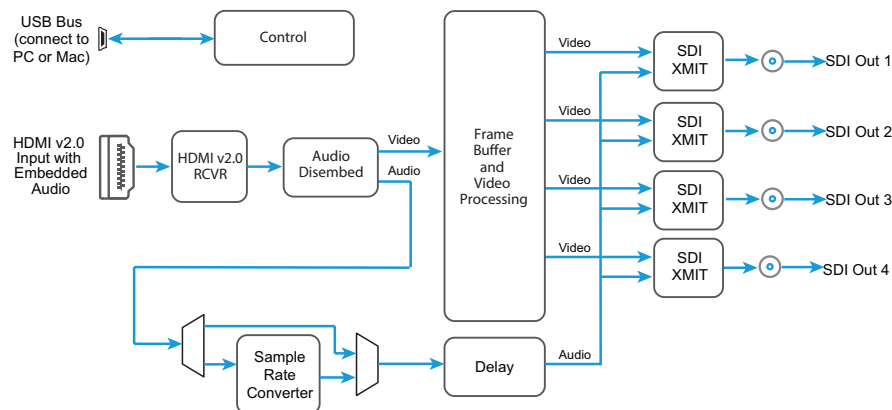

I/O Connections

Figure 2. HA5-4K Converter Connections



NOTE: The LOCK LED adjacent to the HDMI input connector indicates by color the detected signal type. Green is SD, red is HD, amber/orange is 4K/UHD, and off is no signal.

Installation

Typically, HA5-4K installation consists of the following steps:

1. Ensure the HA5-4K is disconnected from power.
2. Connect video equipment to the converter BNCs and HDMI connector.
3. Apply power to the converter (AJA power supply included).
4. The HA5-4K will now run using the default factory settings. If you wish to alter the factory settings, you'll need to:
 - Install the AJA Mini-Config software on your computer
 - Attach the HA5-4K via USB
 - Make your changes using AJA Mini-Config setup screens.

This process is detailed in "[USB Control and Setup—Using AJA Mini-Config](#)" on page 7.

NOTE: The HA5-4K packs an unprecedented feature set into a mini converter box. As a result, the unit uses approximately 10 watts of power. It will be very warm to the touch, which is normal. The unit is engineered to operate across the full temperature range, from 0 to 40 degrees C.

NOTE: For highest reliability, the mini converter relies on convection cooling instead of using a built-in fan. Therefore, when installing the unit, mount in a location where it has access to air for proper cooling. Do not stack the HA5-4K with other mini converters.

Chapter 2 – Operation

USB Control and Setup—Using AJA Mini-Config

Your AJA Mini-Converter can be used right out of the box for some applications since it is designed to recognize inputs and perform standard actions automatically by default. However, to use its full capability, you must use AJA's Mini-Config software application for PCs and Macs. This same application can be used to update to new Mini-Converter software released by AJA.

Acquiring AJA Mini-Config

AJA's Mini-Config application is available for download from the AJA website.

To download the latest AJA Mini-Config package, which includes the AJA Mini-Config application, Mini-Converter firmware, and documentation, go to:

<https://www.aja.com/en/products/mini-converters/mini-config-software>

Select either the Windows or Mac icon to download the desired version.

Mini-Converter Documentation

Included with the AJA Mini-Config package is a complete set of documentation for all Mini-Converters supported by AJA Mini-Config. A .PDF of the *Installation and Operation Guide* for the currently connected Mini-Converter can be accessed from the AJA Mini-Config UI via the **Help/Manual** drop-down menu.

Documentation for all AJA Mini-Converters that use AJA Mini-Config can also be accessed directly in the AJA Mini-Config download package Documentation folder, and via the Documentation icon available on the Mac installer.

Documentation (and firmware) included with the AJA Mini-Config application are the versions available at the time of distribution. However, Mini-Converter software, firmware and documentation are updated regularly, so newer versions may exist.

To download the latest documentation for an individual Mini-Converter, go to:

<https://www.aja.com/en/category/mini-converters>

and navigate to the Support webpage of that Mini-Converter.

Installing AJA Mini-Config

PC Installation

To install AJA Mini-Config on a Windows PC:

1. Download the application from the AJA website (select the Windows icon on the AJA Mini-Config Support webpage).
2. Open the AJA_MiniConfig.zip file
3. Double-click on the MiniInstaller.msi file.
4. A Setup Wizard will guide you through the installation.

Figure 3. AJA Mini-Config PC Setup Wizard

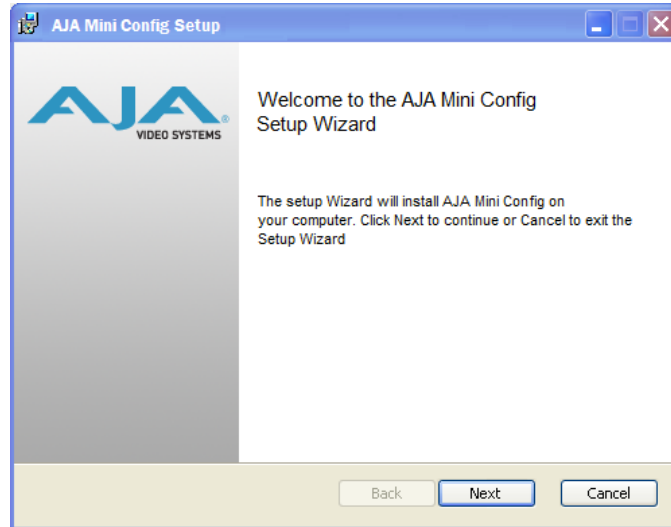

5. Click Next to begin. Answer the questions in the subsequent dialogues. When finished, an AJA Mini-Config shortcut will be installed on the desktop, and you will be able to locate the AJA Mini-Config application in the AJA folder in the Programs listing.

NOTE: If the AJA Mini-Config application already exists on the PC, a different Setup Wizard appears.

Figure 4. AJA Mini-Config Setup Wizard, Reinstallation

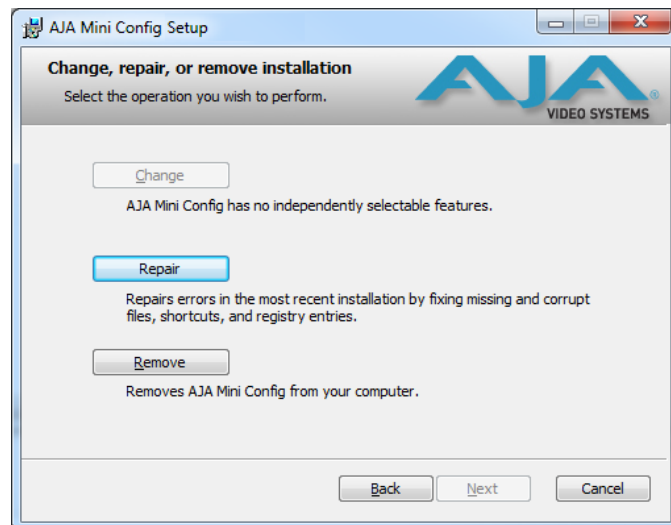

With this screen you can **Repair** (reinstall) or **Remove** (uninstall) AJA Mini-Config on the PC.

Mac Installation

To install the application on a Mac:

NOTE: Macintosh computers must be Intel-based (G5, G4 and earlier models will not work with AJA Mini-Config).

1. Download the application from the AJA website (select the Apple icon on the AJA Mini-Config Support webpage).
2. Open the AJA_MiniConfig folder.
3. Double-click on the AJAMiniConfig.dmg file.

4. Answer the prompt and a utility program will be launched.

Figure 5. AJA Mini-Config Mac Installer

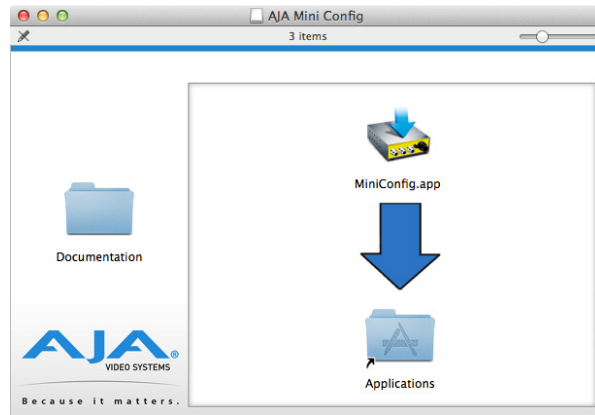

5. To complete the installation drag the "MiniConfig.app" icon to the Applications folder.

Running AJA Mini-Config

Connect the Mini-Converter to the PC or Mac via the supplied USB cable. Connect the external power supply (supplied) to the Mini-Converter.

PC Startup

To run AJA Mini-Config on a PC, double-click on the AJA Mini-Config icon on your desktop, or open the AJA folder in the program list and click on the AJA Mini-Config application located inside the AJA Mini-Config folder.

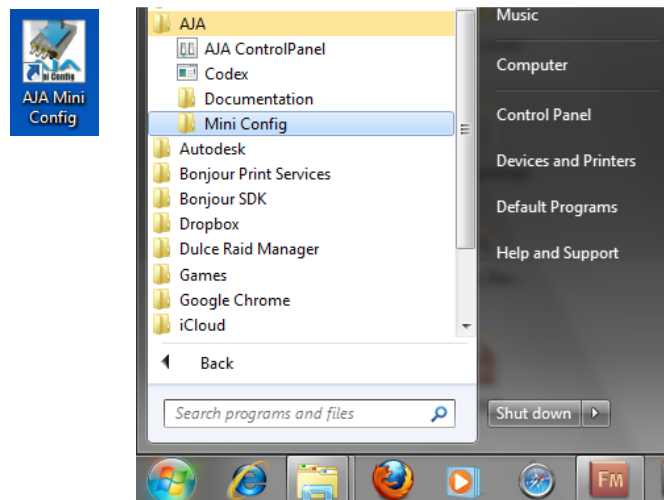

Mac Startup

To run AJA Mini-Config on a Mac, open the Applications folder and locate the AJA Mini-Config application. Double-click the application to launch it.

Saving Setups

A **File** drop down menu on the AJA Mini-Config application bar allows you to save the current state of the Mini-Converter to a preset file for later recall.

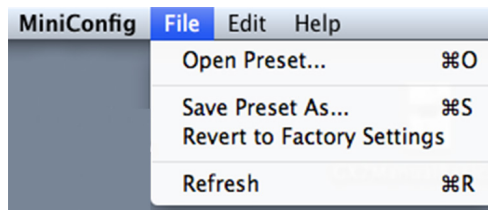

Using this feature you can set up the converter for different applications, storing each configuration (**Save Preset As...**) with a unique name for easy recall (**Open Preset...**).

A **Revert to Factory Settings** menu item similarly allows you to change the settings back to AJA's factory defaults.

Operating AJA Mini-Config

The AJA Mini-Config application provides a graphic interface for viewing settings and updating software. It consists of an information area at the top that shows the available Mini-Converters attached to the computer via USB, with a graphical rendering of the selected Mini-Converter showing all the connectors and their current state.

Colored text next to the connectors indicates the signal type and what the Mini-Converter is doing:

- Blue text indicates the values automatically selected
- Black text indicates values that you have manually selected
- Red text indicates the Mini-Converter is not detecting a signal, or cannot operate with the current user settings.

NOTE: Even if no output device is detected, the SDI connector text still shows the signal it is outputting.

NOTE: Configuration settings in red will change based on the attached output device as well as input signals. For improved accuracy and reliability, you should configure the Mini-Converter only when the target output device is attached and input signals are supplied at the inputs.

Screens are virtually the same on both PC and Mac, with subtle differences that reflect the general look of the platform environment.

Running Multiple Mini-Converters

AJA Mini-Config can manage multiple AJA Mini-Converters connected via USB—even when they are of differing types. However it only connects to one at a time. You can choose which Mini-Converter you wish to control using the pulldown menu in the upper right hand corner. If you want to configure multiple Mini-Converters in parallel, you can do it by running multiple instances of the AJA Mini-Config application and have each control a different Mini-Converter.

NOTE: During a Mini-Converter firmware update, only one Mini-Converter should be connected to the computer via USB.

Figure 6. Example AJA Mini-Config Screen

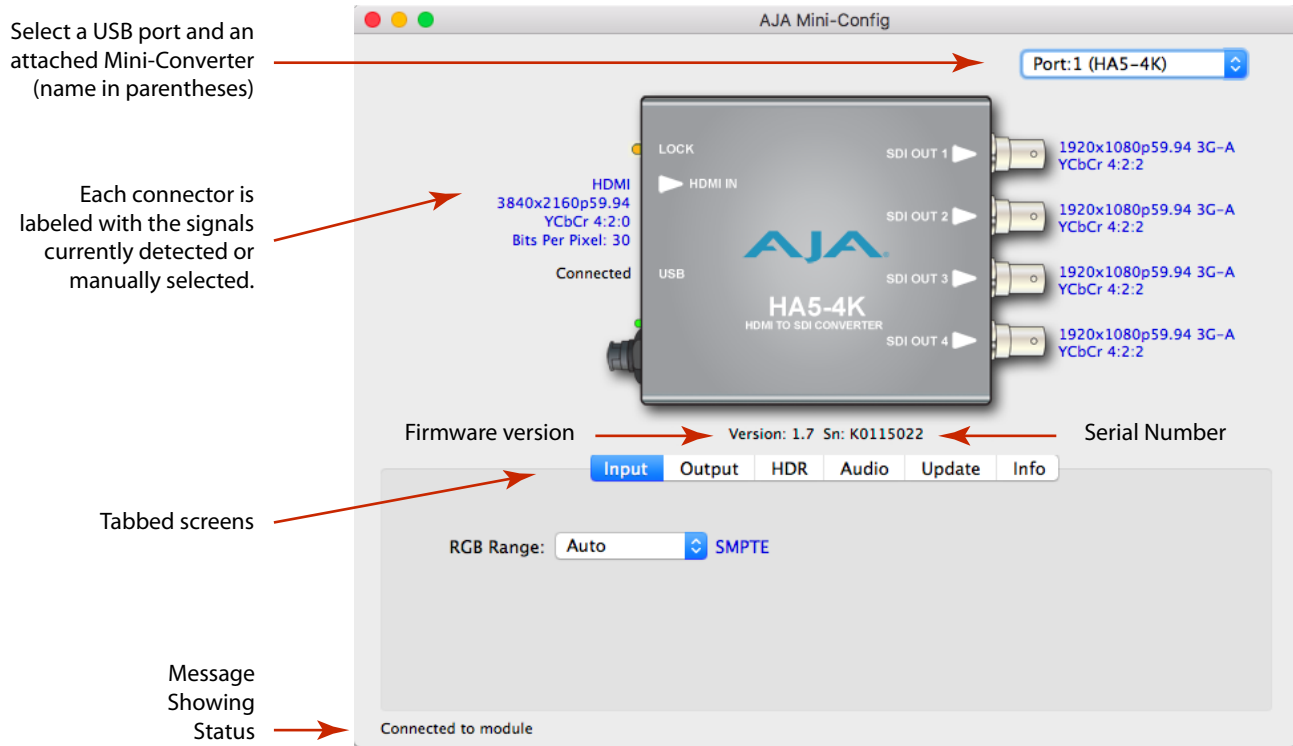

Selecting a Mini-Converter with the pulldown menu causes this application to connect to the selected converter. The graphic of the Mini-Converter and text below it provides:

- Type of converter
- Firmware version
- Serial number of the unit.

A status field at the bottom of the screen shows if your application is connected and communicating with the Mini-Converter.

When configuring the Mini-Converter, select it from the top pulldown, view the current settings and change any values. Making a change communicates that new value to the Mini-Converter's non-volatile memory.

Tabbed Screens

The Tabs delineate control screens with groups of controls for each type of task to be performed. The controls for the actual configuration parameters are specific to each Mini-Converter type. When you Click on any of the tab buttons, the pane below the tabs will change to match your tab selection. Any changes you make are immediately applied and will be saved, overwriting previous settings.

Input Tab Screen

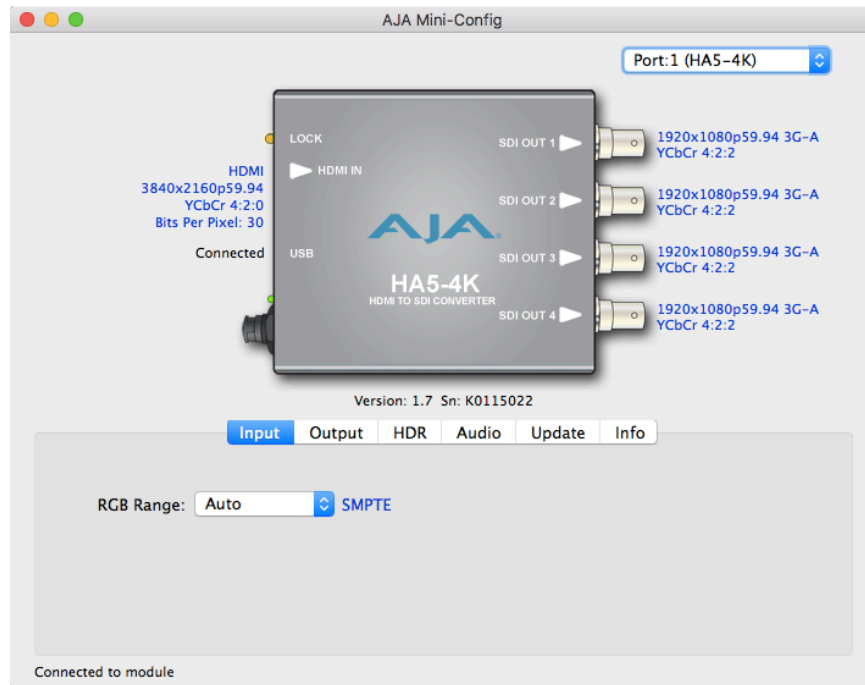

RGB Range

Selects the Input Video Color Range for RGB signals. Choose from:

- Auto (default)
- SMPTE
- Full

Output Tab Screen

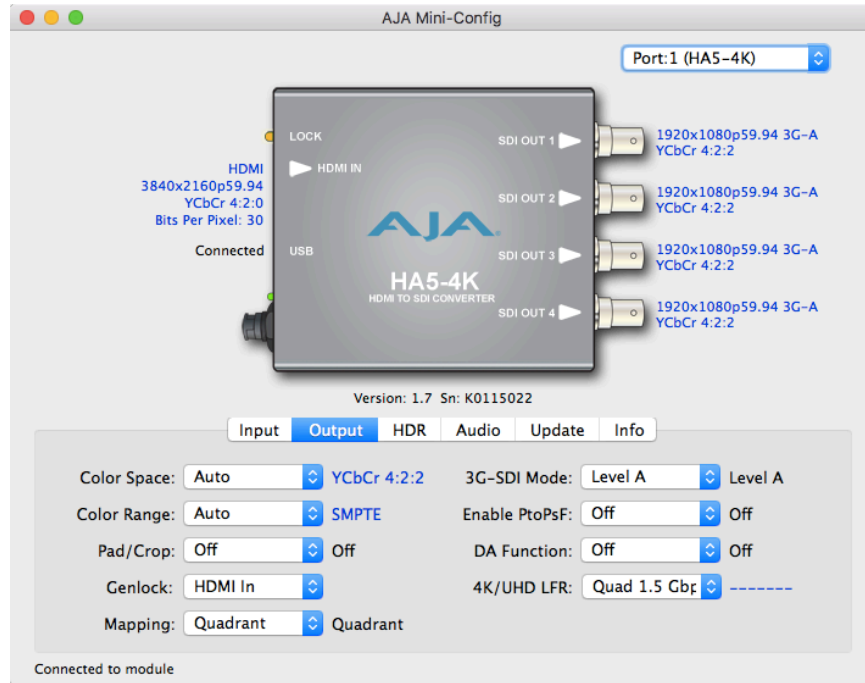

Color Space

Selects the desired output video format. Choose from the following:

- Auto (default) Selects the video format based on the input video and the attached device's capabilities.
- 4:2:2 YCbCr
- 4:4:4 RGB
- 4:4:4 YCbCr (HFR 4K/UltraHD 4:4:4 limited to 8 bit)

Color Range

Selects the Color Range. Choose from the following:

- Auto - (default) Selects SMPTE vs Full based on incoming HDMI and setting of Input Color Range.
- SMPTE
- Full

Pad/Crop

Selects pixel padding and cropping conversions between UltraHD and 4K formats. Choose from the following:

- Off - (default) No processing
- Pad - Add black pixels to the left and right sides of the raster to fill a wider aspect ratio (UltraHD to 4K, or HD to 2K).
- Crop - Crop pixels from left and right sides of the raster to fit a narrower aspect ratio (4K to UltraHD, or 2K to HD).

Genlock

Select the genlock reference. Choose from the following:

- HDMI In (default) - Locks to incoming HDMI clock.
- FreeRun - Locks to free running SDI internal clock.

Mapping

Select the 4K/UltraHD mapping format:

- Quadrant (default) - Square Division
- 2SI - Two Sample Interleave

3G-SDI Mode

Selects the 3G SDI Video Mode. Choose from the following:

- Level A (default)
- Level B-DL

Enable PtoPsF

Choose to convert incoming progressive format HDMI video to PsF SDI video.

- Off - (default) No conversion.
- On - Converts the video to PsF (if it is progressive format and low frame rate).

DA Function

Choose to replicate the signal on any extra BNC outputs. An SD or HD input signal can be distributed to all four BNCs. A 4K/UHD LFR dual stream output signal can be distributed to each pair (1-2 and 3-4) of BNC output connectors.

- Off - (default) no video sent to any extra BNC outputs;
- On - For HD/SD signals, three additional copies of the signal are sent to the SDI Out 2, 3, and 4 BNCs. For dual link output signals one additional copy of the signal is sent to the pair of SDI Out 3 and 4 BNCs.

4K/UHD LFR

Controls how Low Frame Rate (23.98, 24, 25, 29.97, 30 fps) incoming video will be output, using all four BNC outputs (at 1.5 Gbps each), or two BNC outputs (at 3 Gbps each). Choose from the following:

- Quad 1.5 Gbps (default)
- Dual 3 Gbps

HDR Tab Screen

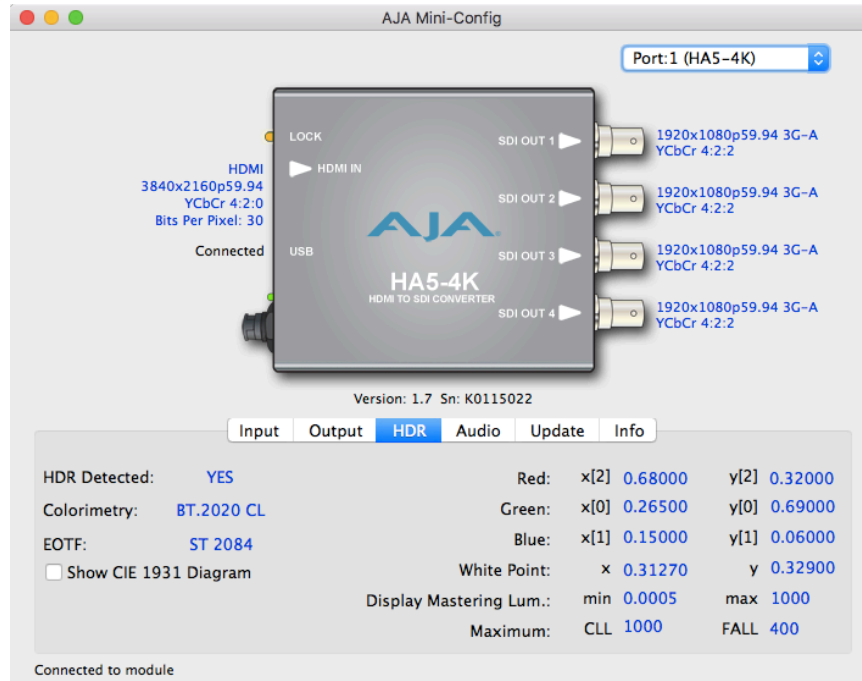

Click on the HDR tab to view the received High Dynamic Range static metadata extensions settings.

The HDR tab displays whether a HDR Infoframe is being received on the HDMI input. If so, it decodes and presents the static metadata descriptors as defined in CTA-861.3 and HDMI v2.0a.

NOTE: The HA5-4K HDR function does not modify the video data.

NOTE: Hover the cursor over each parameter field to view its corresponding description in a pop-up window.

HDR Detected

This field will report YES or NO to indicate whether a HDR Infoframe is being received.

- YES - HDR metadata is being received.
- NO - HDR metadata is not being received.

Colorimetry

This field will report the Colorimetry value received from the AVI Infoframe. This information is always transmitted from an HDMI source, regardless of whether the HDR Infoframe is present.

Status values include the following:

- No Data
- Rec.601
- Rec.709
- BT.2020 Non-CL (non-constant luminance)
- BT.2020 CL (constant luminance)

EOTF

This field will report the Electro-Optical Transfer Function (EOTF) value received from the HDR Infoframe.

Status values include the following:

- Trad Gamma SDR
- Trad Gamma HDR
- ST 2084 (SMPTE ST 2084)
- Hybrid Log-Gamma
- Reserved [4], not yet defined
- Reserved [5], not yet defined
- Reserved [6], not yet defined
- Reserved [7], not yet defined

Display Mastering Luminance

Represents the minimum and maximum Display Mastering Luminance values received in the HDR Infoframe.

- Minimum: Defines the floor of the SMPTE ST 2086 color volume (in the case of HDR) and is determined by the mastering environment.
 - Range: 0.00000 cd/m² to 1.00000 cd/m².
 - Step size: 0.00002 cd/m².
- Maximum: Defines the ceiling of the SMPTE ST 2086 color volume (in the case of HDR) and is determined by the mastering environment.
 - Range: 1 cd/m² to 65535 cd/m².
 - Step size: 1 cd/m².

Maximum Content Light Level (CLL)

Represents the highest-value pixel component in an entire scene. It is determined by analyzing each frame of video, and can be determined in the post environment.

- Range: 1 cd/m² to 65535 cd/m².
- Step size: 1 cd/m².

Maximum Frame Average Light Level (FALL)

Represents the maximum of frame-based average light levels taken over an entire scene, and can be determined in the post environment.

- Range: 1 cd/m² to 65535 cd/m².
- Step size: 1 cd/m².

Audio Tab Screen

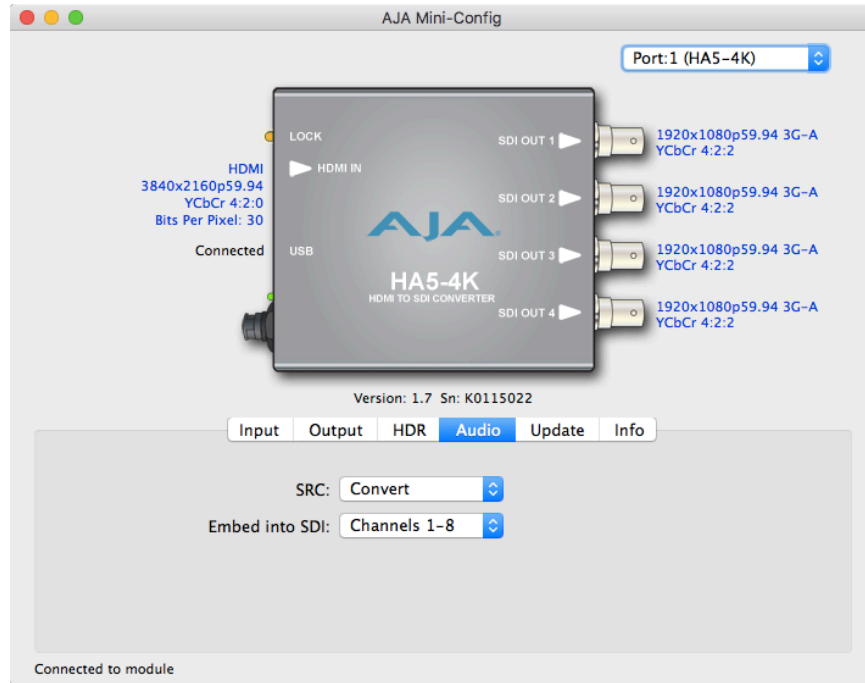

SRC

Choose the audio conversion to be performed on the incoming HDMI audio.

- Convert - HDMI audio will be sample rate converted, if necessary, to 24-bit/48 KHz audio.
- Pass Through - HDMI audio will be passed to the SDI embedded audio channels without conversion.

Embed into SDI

Choose which set of SDI embedded audio output channels will receive up to eight channels of embedded audio received from the incoming HDMI signal. Audio is embedded only into the SDI 1 output link, which may be carried on one or more of the SDI Out BNC connectors, depending on configuration. Choose from the following:

- Channels 1-8
- Channels 9-16

In Quad output mode, the SDI embedded audio will only be sent out the SDI Out 1 BNC.

In Dual output mode, when the DA function is Off the audio will only be sent out the SDI Out 1 BNC. When the DA Function is On, the audio will also be sent out the SDI Out 3 BNC.

In Single output mode, when the DA function is Off the audio will only be sent out the SDI Out 1 BNC. When the DA Function is On, the audio will also be sent out the SDI Out 2, 3, and 4 BNCs.

Update Tab Screen

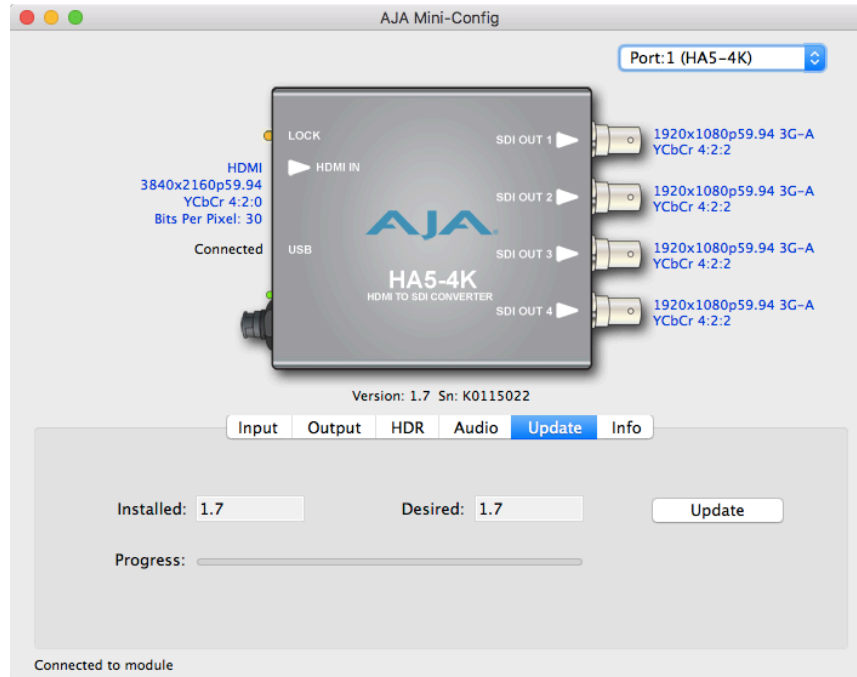

Use this Update screen to view the software version currently installed on the converter or install new firmware.

NOTE: When discussing Mini-Converters, "Firmware" is software that will be stored in the Mini-Converter's non-volatile memory and used when it is powered up. This is something different than the AJA Mini-Config application software. The version numbers shown in the Update screen refer only to the firmware.

Installed - This field shows the version of the firmware currently installed inside the Mini-Converter.

Desired - This field shows the version of firmware embedded in the AJA Mini-Config application which you can install into the Mini-Converter by clicking the Update button.

Update

This button initiates a software update operation loading the "Desired" version of firmware into the Mini-Converter's non-volatile memory.

Progress - This indicator bar shows the progress of firmware installation.

Software Update Procedure

1. Check the AJA website for new AJA Mini-Config software for your Mini-Converter. If new software is found, download it and uncompress the file archive (zip). Here is the URL to use when checking:
<http://www.aja.com/en/products/mini-converters/mini-config-software>
2. Connect the Mini-Converter to a Mac or PC via a USB port on the computer and run the new AJA Mini-Config software just downloaded.
3. Click on the Update tab screen.
4. Check the Installed version level against the Desired version level. If the Desired is newer, then click the Update button to download the new

firmware to the Mini-Converter; progress will be shown via the “Progress” thermometer bar.

Info Tab Screen

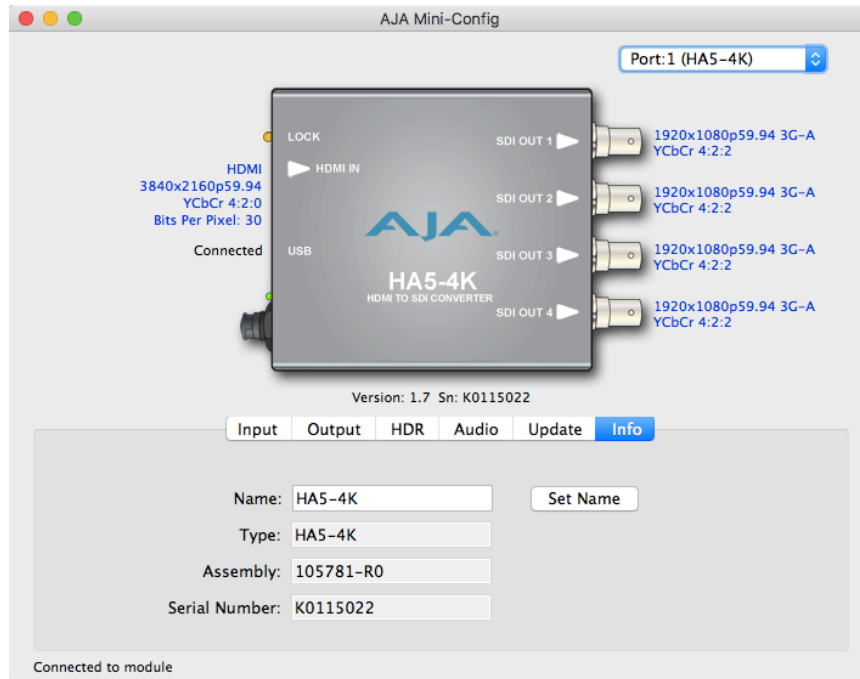

This screen provides basic information about the Mini-Converter. This information is useful when calling AJA Support for service or technical support.

Name

This field allows you to give your Mini-Converter a name. This can be useful if you have several Mini-Converters attached to a Mac/PC via USB so you can distinguish between them easily (especially if they're the same model).

Type - This is the factory set model name of the Mini-Converter.

Assembly - This is the factory assembly number.

Serial Number - This is the factory set unique serial number of your Mini-Converter. If you ever call AJA Support for service, you may be asked for this number.

Appendix A – Specifications

HA5-4K Tech Specs

Video Formats

- (4K) 4096x2160p
- (UltraHD) 3840x2160p
- (2K) 2048x1080p
- (HD) 1920x1080p
- (HD) 1920x1080i
- (HD) 1280x720p
- (SD) 720x576p
- (SD) 720x576i
- (SD) 720x480p
- (SD) 720x480i

Video Input Digital

- 1 x HDMI Type A connector, HDMI v2.0
- YCbCr 4:2:2/4:4:4/4:2:0
- RGB 4:4:4, SMPTE or Full level
- 8, 10, or 12 bit (HFR 4K/UltraHD 4:4:4 limited to 8 bit)
- HDR Infocodec as defined in CTA-861.3 and HDMI v2.0a

- (4K) 4096 x 2160p 23.98, 24, 25, 29.97, 30, 50, 59.94, 60
- (UltraHD) 3840 x 2160p 23.98, 24, 25, 29.97, 30, 50, 59.94, 60
- (2K) 2048 x 1080p 23.98, 24, 25, 29.97, 30, 50, 59.94, 60
- (HD) 1920 x 1080p 23.98, 24, 25, 29.97, 30, 50, 59.94, 60
- (HD) 1920 x 1080i 25, 29.97, 30
- (HD) 1280 x 720p 50, 59.94, 60
- (SD) 720 x 576p 50
- (SD) 720 x 576i 25
- (SD) 720 x 480p 59.94
- (SD) 720 x 480i 29.97

HDCP Decryption

- Not supported. By definition, SDI outputs are unencrypted.

Video Output Digital

- 4 x 3G-SDI BNC, SMPTE-259/292/424
- YCbCr 4:2:2/4:4:4
- RGB 4:4:4, SMPTE or Full level
- 10 bit
- Two Sample Interleave (2SI) or Square Division (Quadrant) source mapping

4 x 3Gb SDI (Level A or B-Dual Link)

- (4K) 4096 x 2160p 23.98, 24, 25, 29.97, 30, 50, 59.94, 60
- (4K) 4096 x 2160PsF* 23.98, 24, 25, 29.97, 30

- (UltraHD) 3840 x 2160p 23.98, 24, 25, 29.97, 30, 50, 59.94, 60
- (Ultra HD) 3840 x 2160PsF* 23.98, 24, 25, 29.97, 30

NOTE: PsF is Level B-Dual Link

4 x 1.5Gb SDI

- (4K) 4096 x 2160p 23.98, 24, 25, 29.97, 30
- (4K) 4096 x 2160PsF 23.98, 24, 25, 29.97, 30
- (UltraHD) 3840 x 2160p 23.98, 24, 25, 29.97, 30
- (UltraHD) 3840 x 2160PsF 23.98, 24, 25, 29.97, 30

2 x 3Gb SDI (Level B-Dual Stream)

- (4K) 4096 x 2160p 23.98, 24, 25, 29.97, 30
- (4K) 4096 x 2160PsF 23.98, 24, 25, 29.97, 30
- (UltraHD) 3840 x 2160p 23.98, 24, 25, 29.97, 30
- (UltraHD) 3840 x 2160PsF 23.98, 24, 25, 29.97, 30

1 x 3Gb SDI (Level A or B-Dual Link)

- (2K) 2048 x 1080p 23.98, 24, 25, 29.97, 30, 50, 59.94, 60
- (2K) 2048 x 1080PsF 23.98, 24, 25, 29.97, 30
- (HD) 1920 x 1080p 23.98, 24, 25, 29.97, 30, 50, 59.94, 60
- (HD) 1920 x 1080PsF 23.98, 24, 25, 29.97, 30
- (HD) 1920 x 1080i 25, 29.97, 30
- (HD) 1280 x 720p* 50, 59.94, 60

NOTE: 1280 x 720p is Level A Only

1 x 1.5Gb SDI

- (2K) 2048 x 1080p 23.98, 24, 25, 29.97, 30
- (2K) 2048 x 1080PsF 23.98, 24, 25, 29.97, 30
- (HD) 1920 x 1080p 23.98, 24, 25, 29.97, 30
- (HD) 1920 x 1080PsF 23.98, 24, 25, 29.97, 30
- (HD) 1920 x 1080i 25, 29.97, 30
- (HD) 1280 x 720p 50, 59.94, 60

1 x 270Mb SDI

- (SD) 625i 25
- (SD) 525i 29.97

Audio Input

- HDMI embedded audio, 24-bit, 8-Channel

Audio Output

- SDI embedded audio, 24-bit, 8-Channel

Size (w x d x h)

- 5.76" x 4.02" x 0.90" (146mm x 102mm x 23mm)

Weight

- 0.55 lb (0.25 kg)

Power

- 5-20VDC regulated, 10 watts, power supply required, included with purchase
- AC Adapter: 100-240VAC, 50/60 Hz, universal input

Environment

- Safe Operating Temperature: 0 to 40 degrees C (32 to 104 degrees F)*
- Safe Storage Temperature (Power OFF): -40 to 60 degrees C (-40 to 140 degrees F)
- Operating Relative Humidity: 10-90% noncondensing
- Operating Altitude: <3,000 meters (<10,000 feet)

NOTE: HA5-4K uses approximately 10 watts of power and convection cooling. It will be warm to the touch, which is normal. When installing the unit, mount in a location where it has access to air for proper cooling. Do not stack the HA5-4K with other Mini-Converters.

Appendix B – Safety and Compliance

Federal Communications Commission (FCC) Compliance Notices

Class B Interference Statement

This equipment has been tested and found to comply with the limits for a Class B digital device, pursuant to Part 15, Subpart B of the FCC Rules. These limits are designed to provide reasonable protection against harmful interference in a residential installation. This equipment generates, uses, and can radiate radio frequency energy and, if not installed and used in accordance with the instructions, may cause harmful interference to radio communications. However, there is no guarantee that interference will not occur in a particular installation. If this equipment does cause harmful interference to radio or television reception, which can be determined by turning the equipment off and on, the user is encouraged to try to correct the interference by one or more of the following measures:

- Reorient or relocate the receiving antenna.
- Increase the separation between the equipment and receiver.
- Connect the equipment into an outlet on a circuit different from that to which the receiver is connected.
- Consult the dealer or an experienced radio/TV technician for help.

FCC Caution

This device complies with Part 15 of the FCC Rules. Operation is subject to the following two conditions: (1) This device may not cause harmful interference, and (2) this device must accept any interference received, including interference that may cause undesired operation.

Canadian ICES Statement

Canadian Department of Communications Radio Interference Regulations

This digital apparatus does not exceed the Class B limits for radio-noise emissions from a digital apparatus as set out in the Radio Interference Regulations of the Canadian Department of Communications. This Class B digital apparatus complies with Canadian ICES-003.

Règlement sur le brouillage radioélectrique du ministère des Communications

Cet appareil numérique respecte les limites de bruits radioélectriques visant les appareils numériques de classe B prescrites dans le Règlement sur le brouillage radioélectrique du ministère des Communications du Canada. Cet appareil numérique de la Classe B est conforme à la norme NMB-003 du Canada.

European Union and European Free Trade Association (EFTA) Regulatory Compliance

This equipment may be operated in the countries that comprise the member countries of the European Union and the European Free Trade Association. These countries, listed in the following paragraph, are referred to as The European Community throughout this document:

AUSTRIA, BELGIUM, BULGARIA, CYPRUS, CZECH REPUBLIC, DENMARK, ESTONIA, FINLAND, FRANCE, GERMANY, GREECE, HUNGARY, IRELAND, ITALY, LATVIA, LITHUANIA, LUXEMBOURG, MALTA, NETHERLANDS, POLAND, PORTUGAL, ROMANIA, SLOVAKIA, SLOVENIA, SPAIN, SWEDEN, UNITED KINGDOM, ICELAND, LICHTENSTEIN, NORWAY, SWITZERLAND

Declaration of Conformity

Marking by this symbol indicates compliance with the Essential Requirements of the EMC Directive of the European Union 2004/108/EC.



This equipment meets the following conformance standards:

Safety

EN 60065: 2002 + A1: 2006 + A11: 2008 + A2: 2010 + A12: 2011 (GS License)

IEC 60065: 2001 + A1: 2005 + A2: 2010 (CB Scheme Report/Certificate)

Additional licenses issued for specific countries available on request.

Emissions

EN 55103-1: 2009, CISPR 22: 2008, EN 55022: 2010,

EN 61000-3-2:2006 +A1:2009 +A2:2009

EN 61000-3-3:2008

Environments: E2, E3 and E4

Immunity

EN 55103-2: 2009,

EN 61000-4-2:2009, EN 61000-4-3:2006+A1:2008+A2:2010, EN 61000-4-4:2004+A1:2010,

EN 61000-4-5:2005, EN 61000-4-6:2009 , EN 61000-4-11:2004

Environments: E2, E3 and E4

The product is also licensed for additional country specific standards as required for the International Marketplace



Warning! This is a Class B product. In a domestic environment, this product may cause radio interference, in which case, the user may be required to take appropriate measures.

Achtung! Dieses ist ein Gerät der Funkstörgrenzwertklasse B. In Wohnbereichen können bei Betrieb dieses Gerätes Rundfunkstörungen auftreten, in welchen Fällen der Benutzer für entsprechende Gegenmaßnahmen verantwortlich ist.

Attention! Ceci est un produit de Classe B. Dans un environnement domestique, ce produit risque de créer des interférences radioélectriques, il appartiendra alors à l'utilisateur de prendre les mesures spécifiques appropriées.

Recycling Notice



This symbol on the product or its packaging indicates that this product must not be disposed of with your other household waste. Instead, it is your responsibility to dispose of your waste equipment by handing it over to a designated collection point for the recycling of waste electrical and electronic equipment. The separate collection and recycling of your waste equipment at the time of disposal will help conserve natural resources and ensure that it is recycled in a manner that protects human health and the environment. For more information about where you can drop off your waste for recycling, please contact your local authority, or where you purchased your product.

Korea KCC Compliance Statement

<p>B급 기기 (가정용 방송통신기자재)</p>	<p>이 기기는 가정용(B급) 전자파적합기기로서 주로 가정에서 사용하는 것을 목적으로 하며, 모든 지역에서 사용할 수 있습니다.</p>
<p>Class B (Broadcasting Communication Equipment for Home Use)</p>	<p>As an electromagnetic wave equipment for home use (Class B), this equipment is intended to use mainly for home use and may be used in all areas.</p>

Taiwan Compliance Statement

警告使用者：
這是甲類的資訊產品，在居住的環境中使用時，可能會造成射頻干擾，在這種情況下，使用者會被要求採取某些適當的對策。

This is a Class B product based on the standard of the Bureau of Standards, Metrology and Inspection (BSMI) CNS 13438, Class B. In a domestic environment this product may cause radio interference in which case the user may be required to take adequate measures.

Japanese Compliance Statement

2. Class B ITE

この装置は、クラスB情報技術装置です。この装置は、家庭環境で使用することを目的としていますが、この装置がラジオやテレビジョン受信機に近接して使用されると、受信障害を引き起こすことがあります。

取扱説明書に従って正しい取り扱いをして下さい。

VCCI-B

This is a Class B product based on the standard of the VCCI Council (VCCI V-3/2011.04). If this is used near a radio or television receiver in a domestic environment, it may cause radio interference. Install and use the equipment according to the instruction manual.

Translated Warning and Caution Messages

The following caution statements, warning conventions, and warning messages apply to this product and manual.



Warning Symbol



Caution Symbol

Before Operation Please Read These Instructions



Warning! Read and follow all warning notices and instructions marked on the product or included in the documentation.

Avertissement! Lisez et conformez-vous à tous les avis et instructions d'avertissement indiqués sur le produit ou dans la documentation.

Warnung! Lesen und befolgen Sie die Warnhinweise und Anweisungen, die auf dem Produkt angebracht oder in der Dokumentation enthalten sind.

¡Advertencia! Lea y siga todas las instrucciones y advertencias marcadas en el producto o incluidas en la documentación.

Aviso! Leia e siga todos os avisos e instruções assinalados no produto ou incluídos na documentação.

Avviso! Leggere e seguire tutti gli avvisi e le istruzioni presenti sul prodotto o inclusi nella documentazione.



Warning! Do not use this device near water and clean only with a dry cloth.

Avertissement! N'utilisez pas cet appareil près de l'eau et nettoyez-le seulement avec un tissu sec.

Warnung! Das Gerät nicht in der Nähe von Wasser verwenden und nur mit einem trockenen Tuch säubern.

¡Advertencia! No utilice este dispositivo cerca del agua y límpielo solamente con un paño seco.

Aviso! Não utilize este dispositivo perto da água e limpe-o somente com um pano seco.

Avviso! Non utilizzare questo dispositivo vicino all'acqua e pulirlo soltanto con un panno asciutto.



Warning! Do not block any ventilation openings. Install in accordance with the manufacturer's instructions.

Avertissement! Ne bloquez aucune ouverture de ventilation. Suivez les instructions du fabricant lors de l'installation.

Warnung! Die Lüftungsöffnungen dürfen nicht blockiert werden. Nur gemäß den Anweisungen des Herstellers installieren.

¡Advertencia! No bloquee ninguna de las aberturas de la ventilación. Instale de acuerdo con las instrucciones del fabricante.

Aviso! Não obstrua nenhuma das aberturas de ventilação. Instale de acordo com as instruções do fabricante.

Avviso! Non ostruire le aperture di ventilazione. Installare in conformità con le istruzioni del fornitore.



Warning! Do not install near any heat sources such as radiators, heat registers, stoves, or other apparatus (including amplifiers) that produce heat.

Avertissement! N'installez pas l'appareil près d'une source de chaleur telle que des radiateurs, des bouches d'air de chauffage, des fourneaux ou d'autres appareils (amplificateurs compris) qui produisent de la chaleur.

Warnung! Nicht in der Nähe von Wärmequellen wie Heizkörpern, Heizregistern, Öfen oder anderen Wärme erzeugenden Geräten (einschließlich Verstärkern) aufstellen.

¡Advertencia! No instale cerca de fuentes de calor tales como radiadores, registros de calor, estufas u otros aparatos (incluidos amplificadores) que generan calor.

Aviso! Não instale perto de nenhuma fonte de calor tal como radiadores, saídas de calor, fogões ou outros aparelhos (incluindo amplificadores) que produzam calor.

Avviso! Non installare vicino a fonti di calore come termosifoni, diffusori di aria calda, stufe o altri apparecchi (amplificatori compresi) che emettono calore



Warning! Do not defeat the safety purpose of the polarized or grounding-type plug. A polarized plug has two blades with one wider than the other. A grounding type plug has two blades and a third grounding prong. The wide blade or the third prong are provided for your safety. If the provided plug does not fit into your outlet, consult an electrician for replacement of the obsolete outlet.

Avertissement! La sécurité de la prise polarisée ou de la prise de type mise à la terre ne doit en aucun cas être empêchée de fonctionner. Une prise polarisée a deux broches, l'une étant plus large que l'autre. Une prise de type mise à la terre a deux broches et une troisième broche pour la mise à la terre. La broche large ou la troisième broche sont fournies pour votre sécurité. Si la prise fournie ne s'insère pas dans votre prise femelle, consultez un électricien pour le remplacement de la prise femelle obsolète.

Warnung! Der Sicherheitszweck des gepolten bzw. Schukosteckers ist zu berücksichtigen. Ein gepolter Stecker verfügt über zwei Pole, von denen einer breiter als der andere ist. Ein Schukostecker verfügt neben den zwei Polen noch über einen dritten Pol zur Erdung. Der breite Pol bzw. der Erdungspol dienen der Sicherheit. Wenn der zur Verfügung gestellte Stecker nicht in Ihren Anschluss passt, konsultieren Sie einen Elektriker, um den veralteten Anschluss zu ersetzen.

¡Advertencia! No eche por tierra la finalidad del tipo de enchufe polarizado con conexión a tierra. Un enchufe polarizado tiene dos espigas, una más ancha que la otra. Un enchufe con conexión a tierra tiene dos espigas iguales y una tercera espiga que sirve para la conexión a tierra. La espiga ancha, o la tercera espiga, sirven para su seguridad. Si el enchufe suministrado no encaja en el tomacorriente, consulte con un electricista para reemplazar el tomacorriente obsoleto.

Aviso! Não anule a finalidade da segurança da ficha polarizada ou do tipo ligação terra. Uma ficha polarizada tem duas lâminas sendo uma mais larga do que a outra. Uma ficha do tipo de ligação à terra tem duas lâminas e um terceiro terminal de ligação à terra. A lâmina larga ou o terceiro terminal são fornecidos para sua segurança. Se a ficha fornecida não couber na sua tomada, consulte um electricista para a substituição da tomada obsoleta.

Avviso! Non compromettere la sicurezza della spina polarizzata o con messa a terra. Una spina polarizzata ha due spinotti, di cui uno più largo. Una spina con messa a terra ha due spinotti e un terzo polo per la messa a terra. Lo spinotto largo o il terzo polo sono forniti per motivi di sicurezza. Se la spina fornita non si inserisce nella presa di corrente, contattare un elettricista per la sostituzione della presa obsoleta.



Warning! Since the Mains plug is used as the disconnection for the device, it must remain readily accessible and operable.

Avertissement! Puisque la prise principale est utilisée pour débrancher l'appareil, elle doit rester aisément accessible et fonctionnelle.

Warnung! Da der Netzstecker als Trennvorrichtung dient, muss er stets zugänglich und funktionsfähig sein.

¡Advertencia! Puesto que el enchufe de la red eléctrica se utiliza como dispositivo de desconexión, debe seguir siendo fácilmente accesible y operable.

Aviso! Dado que a ficha principal é utilizada como a desconexão para o dispositivo, esta deve manter-se prontamente acessível e funcional.

Avviso! Poiché il cavo di alimentazione viene usato come dispositivo di sconnessione, deve rimanere prontamente accessibile e operabile.



Warning! Protect the power cord from being walked on or pinched particularly at plugs, convenience receptacles, and the point where they exit from the device.

Avertissement! Protégez le cordon d'alimentation pour que l'on ne marche pas dessus ou qu'on le pince, en particulier au niveau des prises mâles, des réceptacles de convenance, et à l'endroit où il sort de l'appareil.

Warnung! Vermeiden Sie, dass auf das Netzkabel getreten oder das Kabel geknickt wird, insbesondere an den Steckern, den Steckdosen und am Kabelausgang am Gerät.

¡Advertencia! Proteja el cable de energía para que no se le pise ni apriete, en especial cerca del enchufe, los receptáculos de conveniencia y el punto del que salen del equipo.

Aviso! Proteja o cabo de alimentação de ser pisado ou de ser comprimido particularmente nas fichas, em tomadas de parede de conveniência e no ponto de onde sai do dispositivo.

Avviso! Proteggere il cavo di alimentazione in modo che nessuno ci cammini sopra e che non venga schiacciato soprattutto in corrispondenza delle spine e del punto in cui esce dal dispositivo.



Warning! Unplug this device during lightning storms or when unused for long periods of time.

Avertissement! Débranchez cet appareil pendant les orages avec éclaircies s'il est inutilisé pendant de longues périodes.

Warnung! Das Gerät ist bei Gewitterstürmen oder wenn es über lange Zeiträume ungenutzt bleibt vom Netz zu trennen.

¡Advertencia! Desenchufe este dispositivo durante tormentas eléctricas o cuando no se lo utilice por largos periodos del tiempo.

Aviso! Desconecte este dispositivo da tomada durante trovoadas ou quando não é utilizado durante longos períodos de tempo.

Avviso! Utilizzare soltanto i collegamenti e gli accessori specificati e/o venduti dal produttore, quali il treppiedi e l'esoscheletro.



Warning! Do not open the chassis. There are no user-serviceable parts inside. Opening the chassis will void the warranty unless performed by an AJA service center or licensed facility.

Avertissement! Ne pas ouvrir le châssis. Aucun élément à l'intérieur du châssis ne peut être réparé par l'utilisateur. La garantie sera annulée si le châssis est ouvert par toute autre personne qu'un technicien d'un centre de service ou d'un établissement agréé AJA.

Warnung! Öffnen Sie das Gehäuse nicht. Keine der Geräteteile können vom Benutzer gewartet werden. Durch das Öffnen des Gehäuses wird die Garantie hinfällig, es sei denn, solche Wartungsarbeiten werden in einem AJA-Service-Center oder einem lizenzierten Betrieb vorgenommen.

¡Advertencia! No abra el chasis. El interior no contiene piezas reparables por el usuario. El abrir el chasis anulará la garantía a menos que se lo haga en un centro de servicio AJA o en un local autorizado.

Advertência! Não abra o chassi. Não há internamente nenhuma peça que permita manutenção pelo usuário. Abrir o chassi anula a garantia, a menos que a abertura seja realizada por uma central de serviços da AJA ou por um local autorizado.

Avvertenza! Non aprire lo chassis. All'interno non ci sono parti riparabili dall'utente. L'apertura dello chassis invaliderà la garanzia se non viene effettuata da un centro ufficiale o autorizzato AJA.



Warning! Disconnect the external AC power supply line cord(s) from the mains power before moving the unit.

Avertissement! Retirez le ou les cordons d'alimentation en CA de la source d'alimentation principale lorsque vous déplacez l'appareil.

Warnung! Trennen Sie die Wechselstrom-Versorgungskabel vom Netzstrom, bevor Sie das Gerät verschieben.

¡Advertencia! Cuando mueva la unidad desenchufe de la red eléctrica el/los cable(s) de la fuente de alimentación CA tipo brick.

Advertência! Remova os cabos CA de alimentação brick da rede elétrica ao mover a unidade.

Avvertenza! Scollegare il cavo dell'alimentatore quando si sposta l'unità.



Warning! Refer all servicing to qualified service personnel. Servicing is required when the device has been damaged in any way, such as power-supply cord or plug is damaged, liquid has been spilled or objects have fallen into the device, the device has been exposed to rain or moisture, does not operate normally, or has been dropped.

Avertissement! Référez-vous au personnel de service qualifié pour tout entretien. L'entretien est exigé quand l'appareil a été endommagé de quelque manière que ce soit, par exemple lorsque le cordon d'alimentation ou la prise sont endommagés, que du liquide a été versé ou des objets sont tombés dans l'appareil, que l'appareil a été exposé à la pluie ou à l'humidité, ne fonctionne pas normalement ou est tombé.

Warnung! Das Gerät sollte nur von qualifizierten Fachkräften gewartet werden. Eine Wartung ist fällig, wenn das Gerät in irgendeiner Weise beschädigt wurde, wie bei beschädigtem Netzkabel oder Netzstecker, falls Flüssigkeiten oder Objekte in das Gerät gelangen, das Gerät Regen oder Feuchtigkeit ausgesetzt wurde, nicht ordnungsgemäß funktioniert oder fallen gelassen wurde.

¡Advertencia! Consulte al personal calificado por cuestiones de reparación. El servicio de reparación se requiere cuando el dispositivo ha recibido cualquier tipo de daño, por ejemplo cable o espigas dañadas, se ha derramado líquido o se han caído objetos dentro del dispositivo, el dispositivo ha sido expuesto a la lluvia o humedad, o no funciona de modo normal, o se ha caído.

Aviso! Remeta todos os serviços de manutenção para o pessoal de assistência qualificado. A prestação de serviços de manutenção é exigida quando o dispositivo foi danificado mediante qualquer forma, como um cabo de alimentação ou ficha que se encontra danificado/a, quando foi derramado líquido ou caíram objectos sobre o dispositivo, quando o dispositivo foi exposto à chuva ou à humidade, quando não funciona normalmente ou quando foi deixado cair.

Avviso! Fare riferimento al personale qualificato per tutti gli interventi di assistenza. L'assistenza è necessaria quando il dispositivo è stato danneggiato in qualche modo, ad esempio se il cavo di alimentazione o la spina sono danneggiati, è stato rovesciato del liquido è stato rovesciato o qualche oggetto è caduto nel dispositivo, il dispositivo è stato esposto a pioggia o umidità, non funziona correttamente o è caduto

Five Year Warranty

Limited Warranty

AJA Video Systems, Inc. (AJA Video) warrants that this product will be free from defects in materials and workmanship for a period of five years from the date of purchase. If a product proves to be defective during this warranty period, AJA Video, at its option, will either repair the defective product without charge for parts and labor, or will provide a replacement in exchange for the defective product.

In order to obtain service under this warranty, you the Customer, must notify AJA Video of the defect before the expiration of the warranty period and make suitable arrangements for the performance of service. The Customer shall be responsible for packaging and shipping the defective product to a designated service center nominated by AJA Video, with shipping charges prepaid. AJA Video shall pay for the return of the product to the Customer if the shipment is to a location within the country in which the AJA Video service center is located. Customer shall be responsible for paying all shipping charges, insurance, duties, taxes, and any other charges for products returned to any other locations.

This warranty shall not apply to any defect, failure or damage caused by improper use or improper or inadequate maintenance and care. AJA Video shall not be obligated to furnish service under this warranty a) to repair damage resulting from attempts by personnel other than AJA Video representatives to install, repair or service the product, b) to repair damage resulting from improper use or connection to incompatible equipment, c) to repair any damage or malfunction caused by the use of non-AJA Video parts or supplies, or d) to service a product that has been modified or integrated with other products when the effect of such a modification or integration increases the time or difficulty of servicing the product.

THIS WARRANTY IS GIVEN BY AJA VIDEO IN LIEU OF ANY OTHER WARRANTIES, EXPRESS OR IMPLIED. AJA VIDEO AND ITS VENDORS DISCLAIM ANY IMPLIED WARRANTIES OF MERCHANTABILITY OR FITNESS FOR A PARTICULAR PURPOSE. AJA VIDEO'S RESPONSIBILITY TO REPAIR OR REPLACE DEFECTIVE PRODUCTS IS THE WHOLE AND EXCLUSIVE REMEDY PROVIDED TO THE CUSTOMER FOR ANY INDIRECT, SPECIAL, INCIDENTAL OR CONSEQUENTIAL DAMAGES IRRESPECTIVE OF WHETHER AJA VIDEO OR THE VENDOR HAS ADVANCE NOTICE OF THE POSSIBILITY OF SUCH DAMAGES.